

1

2

3

4

5

6

A

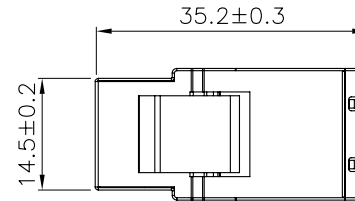
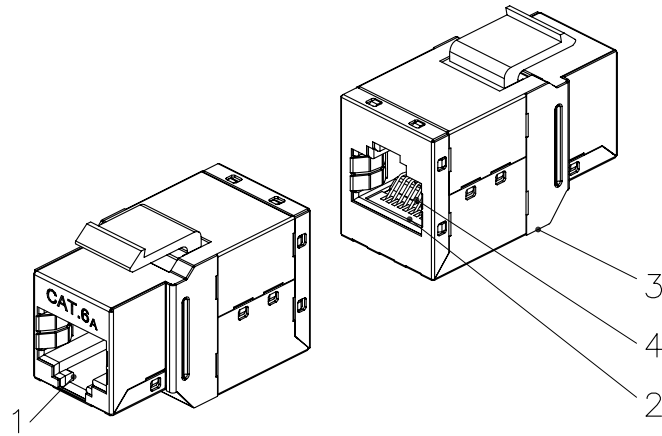

SCALE 1/1

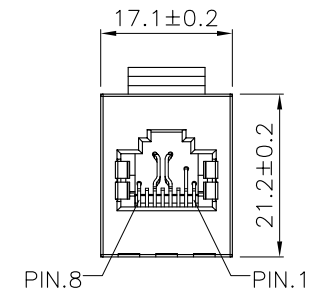
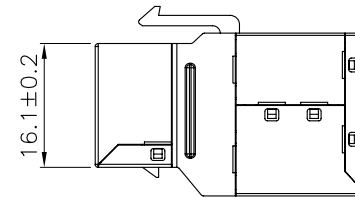
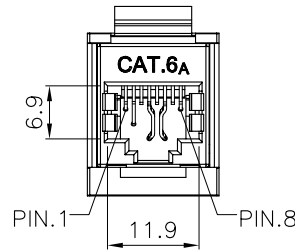

B

B

C

C

Specification :

Material :



1. RJ45 Jack Housing : ABS+PC, UL 94V-0, with Black color.
2. Contact Bracket : PC, UL 94V-2, Transparent color.
3. RJ45 Jack Shield : Bronze with Nickel plated.
4. RJ45 Jack Contact :
 - 4-1. Material : Phosphor Bronze with Nickel plated.
 - 4-2. Finish : 50 micro-inch Gold plated on Plug contact area.
5. PCB : FR4, UL 94V-0.

Performance :

- a. Insertion force : 30N max. (IEC 60603-7-5)
- b. Retention strength : 7.7 kg between Jack and Plug.
- c. Operating temperature : -10°C to 60°C. (ISO/ICE 11801, ANSI/TIA/EIA 568 B.2)
- d. Life(mating cycles) : Jack : 750 cycles min. (ISO/IEC 11801, IEC 60603-7-5)
- e. The CAT.6A channel transmission performance is in compliance with TIA/EIA 568C.2 10G & ISO/IEC 11801 standard.

D

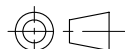
D

| | | | | |
|---|---|------------------------|------|--|
| GENERAL TOLERANCE OF DIMENSIONS ±0.1 | DRAWING | | |  we move the world |
| | CHECK | | | |
| | APPROVAL | | | |
| | | DATE | NAME | ITEM NO.: |
| | SCALE | (A4) | UNIT | |
| |  | DRAWING NO. | | |
| | | DRAWING CLASSIFICATION | |  |

1

2

0

3

4

10cm

5